

# Low Volume Spray Solutions

*Next Level Spraying Precision*

**MONTFORT INTERNATIONAL Ltd**  
2500 avenue Watt, Québec (QUÉBEC) Canada G1P 3T3  
+ 1 (418) 877-0778 - (800) 463-6668 - [info@montfort-international.com](mailto:info@montfort-international.com)

## Versatility & Control

When you need precise control of your spray, the Unist Low Volume Spray Nozzles deliver with a consistent and controlled spray pattern. The air and fluid volumes are controlled independently for each nozzle with precision needle valves, allowing you to fine tune the spray to your specific needs. An integral valve at the nozzle tip means our system features immediate on and off control, which eliminates lag and prevents messy fluid drips.

- Valve at nozzle tip eliminates messy drips
- Immediate on/off spray control
- Fine control of spray pattern
- Individual air & fluid control
- Air actuated design



### Air Actuated

The nozzle is operated with a compressed air signal, which allows the pressurized fluid to flow whenever the air signal is present. An internal valve at the nozzle tip allows crisp on/off control.



### Precise Control

Independent precision needle valves for liquid and air allow you to dial in a finely-tuned spray to suit your application and fluid type.

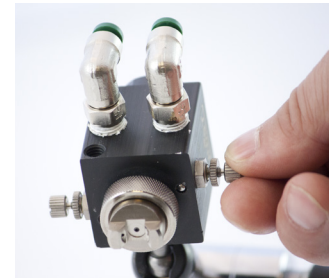

## Adjustment Options

### Standard Adjustment

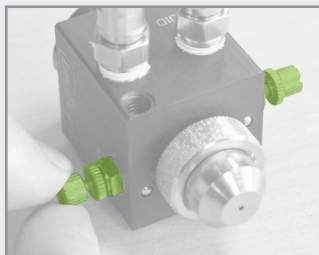

Adjust the fluid and air right at the nozzle

### Remote Adjustment

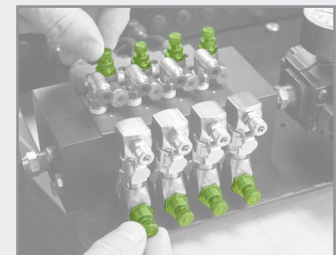

Adjust the fluid and air at the remote adjustment solenoid valve bank on the SPR-2000™ programmable fluid controller



## Control & Monitor Multiple Nozzles

Combine your Unist Low Volume Spray Nozzles with a Unist SPR-2000™ programmable fluid controller and pressure tank for precise control of spray frequency and duration.

The SPR-2000™ is capable of controlling 22 independent Low Volume Spray Nozzles and monitoring critical parameters such as fluid level, fluid pressure, and flow and is a great choice for controlling your present and future stock lubrication systems.

## Typical Applications

### Broad Conical Spray Pattern

The Low Volume Spray Nozzle with conical spray tip provides the perfect spray pattern for spot lubrication or coating.

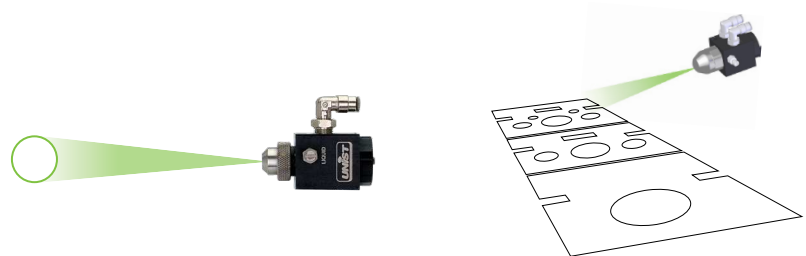

### Fan Spray Pattern

The fan spray tip converts the Low Volume Spray Nozzle into a precision coating applicator. Multiple nozzles can be ganged together to cover wide areas with overlapping fan spray.



### Narrow Conical Spray Pattern

The Low Volume Spray Nozzle can be used to deliver a precise, fine-tuned spray. This extended nozzle design allows you to reach tight areas that otherwise might be difficult to access.

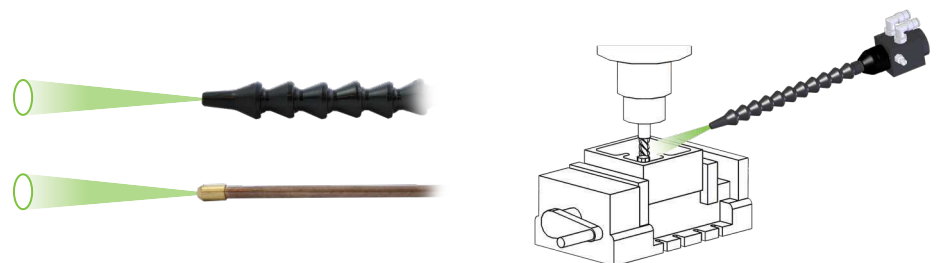

## Build Your System: Low Volume Spray System Components

### Nozzle



Fan spray

or



Conical spray

or



Semi-rigid copper

or



Loc-Line®

### Control



SPR-2000™  
programmable fluid controller

or



Manual valve\*

or



Solenoid valve\*  
110 VAC, 220 VAC, 24 VDC

or



Solenoid valve bank\*  
110 VAC, 220 VAC, 24 VDC

or



Remote adjustment  
solenoid valve bank  
110 VAC, 220 VAC, 24 VDC

### Supply



3 gallon [11 L] stainless

or



6 gallon [23 L] ASME rated

or



15 gallon [57 L] ASME rated

or



Diaphragm pump

### Mounting



Articulating arm

or



Adjustable magnet mount

or



Modular mounting system

\*Only available with the standard adjustment nozzle.

## Build Your System: Modular Mounting

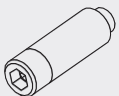

Nozzle stud

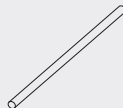

Mounting rod

Cut to size from 6-48"  
[152.4-1219.2 mm]

Lengths in 6" [152.4 mm]  
increments

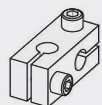

Bar clamp

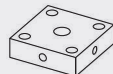

Square base plate

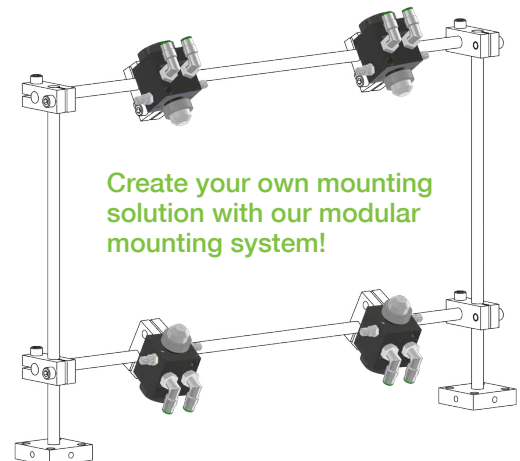

Create your own mounting solution with our modular mounting system!

## Build Your System: System Examples

### Simple Manual Valve Operation

A Low Volume Spray Nozzle can be configured as a simple on demand spray system. The system is actuated with a push-button manual valve for immediate spray when needed.

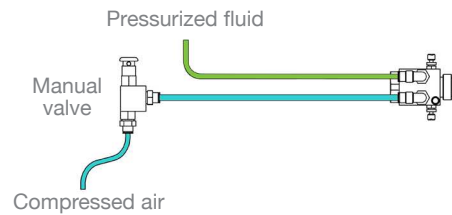

### Solenoid Valve Operation

When automation or multiple nozzles are required, Low Volume Spray Nozzles can be actuated by solenoid valves. This configuration allows independent control of multiple nozzles. Solenoid valves are available in several voltages including 110 VAC, 220 VAC, and 24 VDC.

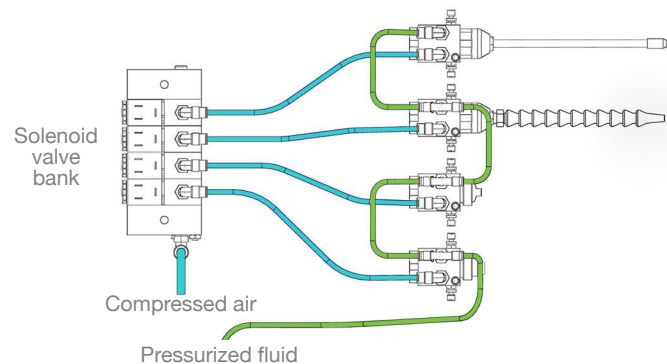

### SPR-2000™ Operation

Low Volume Spray Nozzles combined with the SPR-2000™ controller are the key components for reliably and accurately controlling the application of metal forming lubricants.

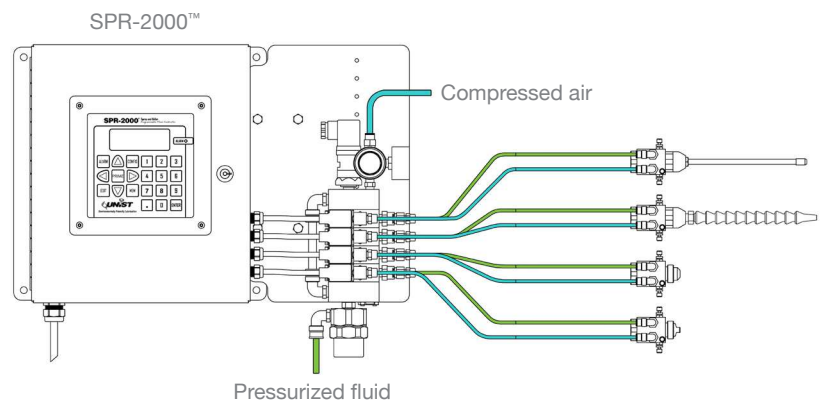

### SPR-2000™ Operation With Remote Adjustment

Low Volume Spray Nozzles with remote adjustment and the SPR-2000™ controller control the application of metal forming lubricants and keep all controls in a central location.

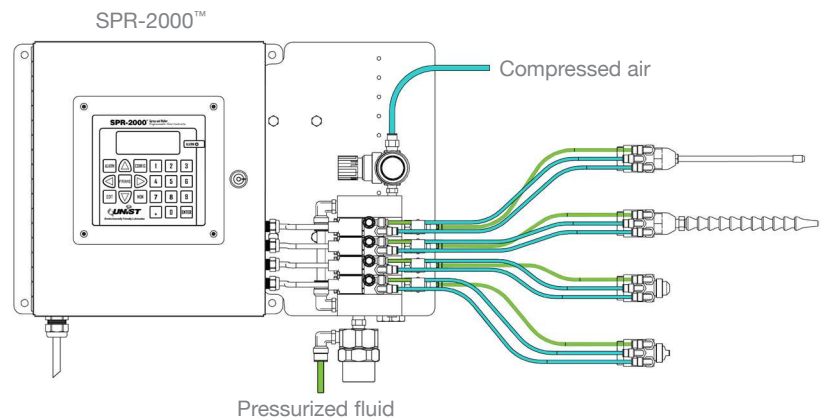

## Low Volume Spray Nozzle Spray Patterns

(For standard & remote adjustment nozzles)

### Fan Spray



Approximate spray dimensions	
B	W*
3" [76 mm]	7.5" [191 mm]
6" [152 mm]	12" [305 mm]
9" [229 mm]	15" [381 mm]
12" [305 mm]	18" [457 mm]
15" [381 mm]	23" [584 mm]
18" [457 mm]	26" [660 mm]

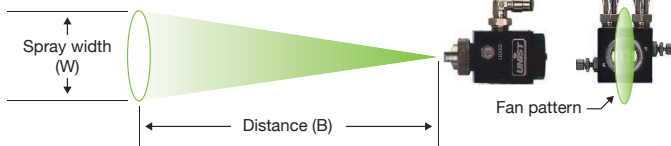

### Conical Spray



Approximate spray dimensions	
B	D*
3" [76 mm]	1.25" [32 mm]
6" [152 mm]	2.25" [57 mm]
12" [305 mm]	3.50" [89 mm]
18" [457 mm]	4.25" [108 mm]
24" [610 mm]	5.50" [140 mm]
30" [762 mm]	6.75" [172 mm]

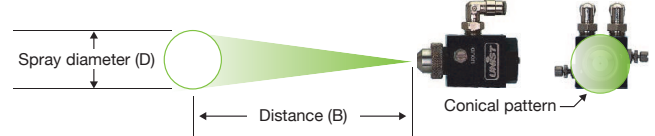

\* Data approximates spray pattern for the Low Volume Spray Nozzles. Please note that these values are a guideline for initial nozzle setup. Actual spray pattern will vary depending on the applied fluid, air and fluid pressures, and metering screw settings.

## Low Volume Spray Nozzle Dimensions

(For standard & remote adjustment nozzles)

- 1/4-20 Mounting hole
- M6 X 1 Mounting hole

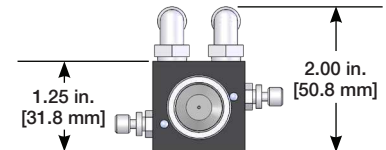
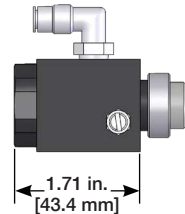
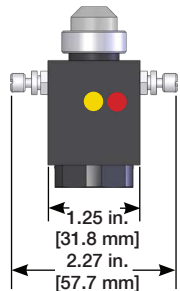

## Low Volume Spray Nozzle Specifications

(For standard & remote adjustment nozzles)

- **Air supply pressure:** 40-100 psi [2-7 bar] (dry filtered compressed air)
- **Fluid supply pressure:** 5-100 psi [0.34-7 bar]
- **Maximum cycle rate:** 200 cycles per min
- **Operating temp range:** 40-150°F [4-65°C]
- **Body:** Anodized aluminum
- **Needle valves:** Stainless steel
- **Fittings:** Nickel-plated brass
- **Fluid seal material:** Fluorocarbon (Viton)
- **Air seal material:** Nitrile (Buna-N)